

Vector Network Analyzer

- Vector – phase and amplitude, complex impedance, resistance, capacitance, inductance
- Network – one or two port circuit systems
- Analyzer – comprehensive measurement and test suites
- I sold these for \$10,000-\$50,000 in the 80's



HP (Agilent) 3577A Vector Network Analyzer, 5Hz -200MHz, refurb tested good

🔥 2 viewed per hour ★★★★★ 2 product ratings

Condition: **Seller refurbished**

“Late-model HP 3577A VNA , refurbished, tested good and in very good condition.”

Price: **US \$1,095.00**
\$46 for 24 months *

Buy It Now

Add to cart

♥ Add to Watchlist

Ships from United States

Shipping: **\$92.49** Standard Shipping | [See details](#)

Item location: Santa Fe, New Mexico, United States

Ships to: United States [See exclusions](#)

NanoVNA

- The open source NanoVNA project by @edy555 and ttrfttech has been around since 2016, but only recently have Chinese sellers begun mass producing the unit
- Bought one for \$28 from Walmart.com!
- Reviewed favorably same month in both QST and QEX!
- Tremendous community support and great software – Windows, Mac, Android
- Top of my list of recommended ham test equipment, replace most antenna analyzers
- Surprisingly excellent manual



← Back to results

50KHz-900MHz Mini Vector Network Analyzer HF VHF UHF Antenna Analyzer with 2.8 Inch Digital LCD Display Touching Screen Standing Wave Measuring Instrument
by WonVon

Price: **\$46.99** ✓prime & FREE Returns

- This is a DIY product that provides perfect vector network measurement capabilities in the size of a credit card. It includes a 2.8-inch touch screen and 500mAh battery, which can be used offline for 2 hours. For longer measurement, please connect external power supply or contact me to make a larger battery version.
- Simple and practical PC control software, you can export Touchstone (snp) files for various radio design and simulation software through PC software.
- The improved frequency algorithm can use the odd harmonic extension of si5351 to support the measurement frequency up to 900MHz. The metal shield is designed to reduce the external interference and improve the measurement accuracy.
- The 50535-300MHz frequency range of the si5351 direct output provides better than 70dB dynamic. The extended 300M-600MHz band provides better than 60dB of dynamics, and the 600M-900M band is better than 50dB of dynamics.
- The TX/RX method can measure the complete S11 and S21 parameters. If you need to obtain S12 and S22, you need to manually replace the transceiver port wiring.

Roll over image to zoom in

New “f” version

4.3 inch display

Nice and much easier touch control,
but NanoVNA Saver program gives whatever size display
you want and infinitely more control – One of the best
softwares I have encountered

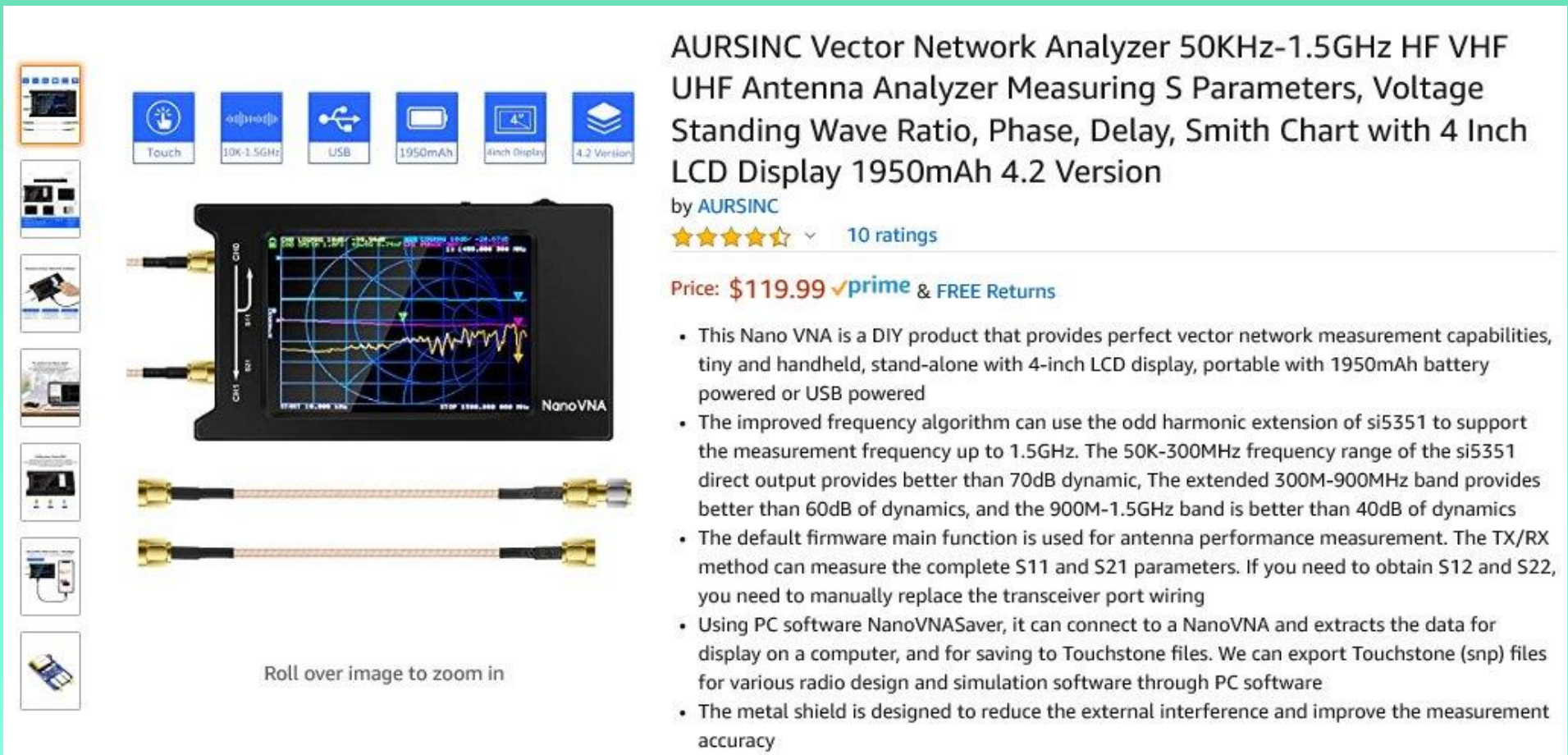

AURSINC Vector Network Analyzer 50KHz-1.5GHz HF VHF UHF Antenna Analyzer Measuring S Parameters, Voltage Standing Wave Ratio, Phase, Delay, Smith Chart with 4 Inch LCD Display 1950mAh 4.2 Version

by AURSINC

★★★★★ 10 ratings

Price: \$119.99 ✓prime & FREE Returns

- This Nano VNA is a DIY product that provides perfect vector network measurement capabilities, tiny and handheld, stand-alone with 4-inch LCD display, portable with 1950mAh battery powered or USB powered
- The improved frequency algorithm can use the odd harmonic extension of si5351 to support the measurement frequency up to 1.5GHz. The 50K-300MHz frequency range of the si5351 direct output provides better than 70dB dynamic, The extended 300M-900MHz band provides better than 60dB of dynamics, and the 900M-1.5GHz band is better than 40dB of dynamics
- The default firmware main function is used for antenna performance measurement. The TX/RX method can measure the complete S11 and S21 parameters. If you need to obtain S12 and S22, you need to manually replace the transceiver port wiring
- Using PC software NanoVNASaver, it can connect to a NanoVNA and extracts the data for display on a computer, and for saving to Touchstone files. We can export Touchstone (snp) files for various radio design and simulation software through PC software
- The metal shield is designed to reduce the external interference and improve the measurement accuracy

Roll over image to zoom in

Walkaround



- USB-C
- Multifunction switch – Press, roll right or left
- Touch screen – can work with my big fingers, but recommend stylus
- 101 sample points – limits narrowband analysis, BUT, software supports multiple 101 point “segments!”

- 2 SMA female ports
- S_{nm} - power from port m to port n
- S₁₁ - power from port 1 (CH0) to port 1 – reflected power
- S₂₁ – power from port 1 to port 2 (CH1)

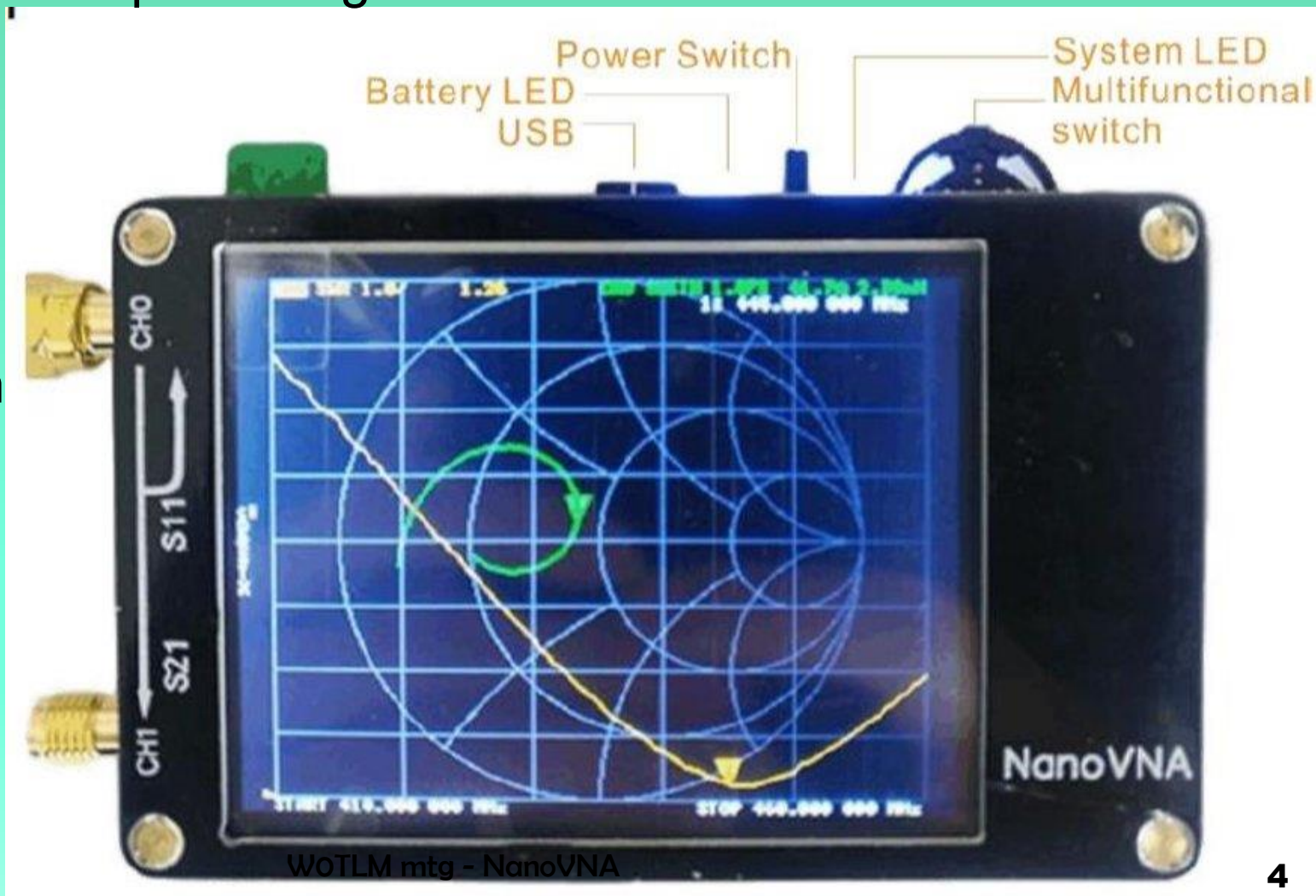

Screen

Busy, but very readable and informative

- 1 - Start frequency
- 2 - Stop frequency
- 3 - Markers - very powerful - number at same frequency on all traces
- 4 - Calibration status
- 5 - Reference position
- 6 - Marker status, active, previous active
- 7 - Trace status – CH (0, 1) selected inverse, Format, Scale, Current value
- 8 – Battery status

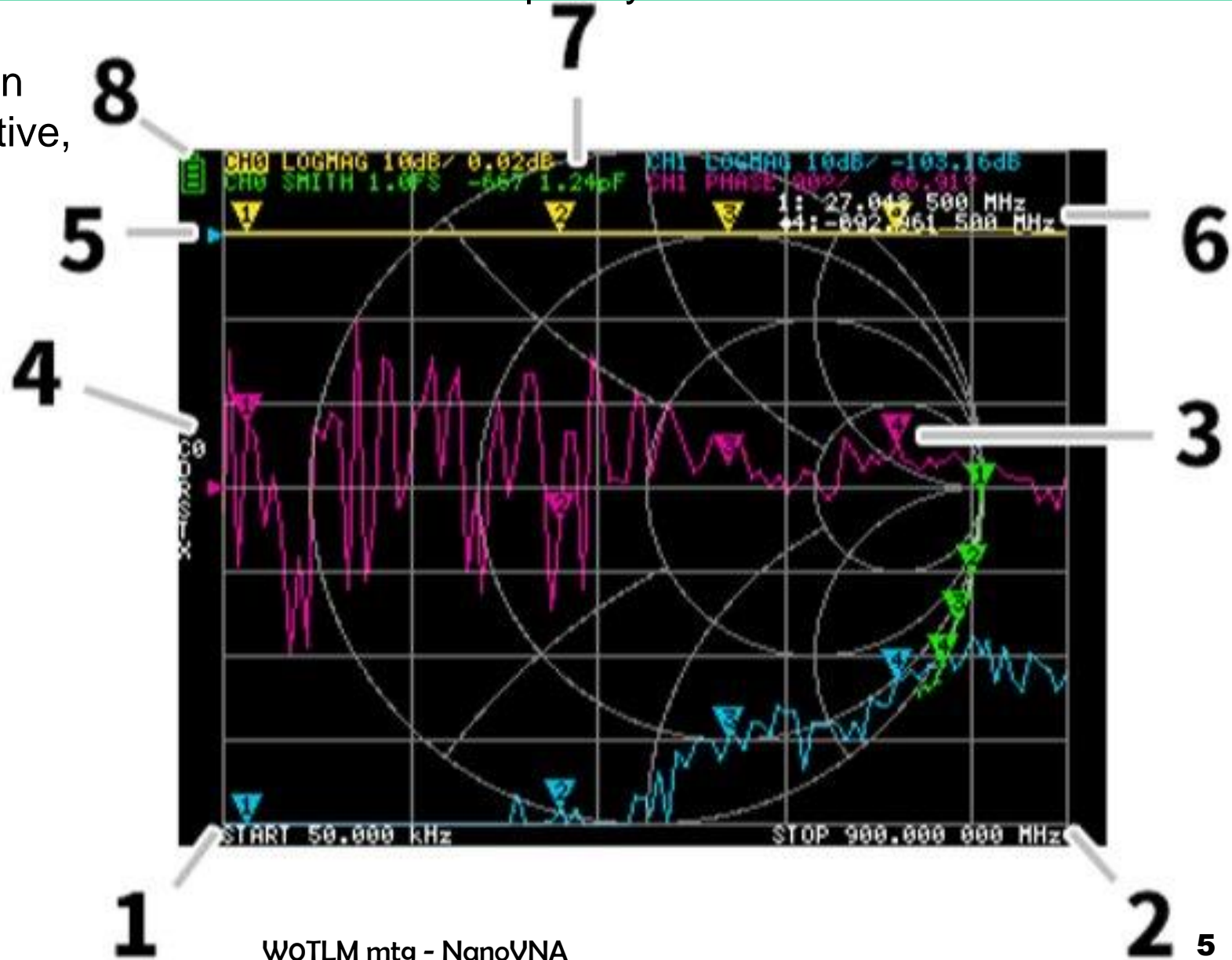

Quick look at user interface – better than expected

- Touch open area or push control to popup menu
- Touch menu item or roll control to select
- Touch number pad

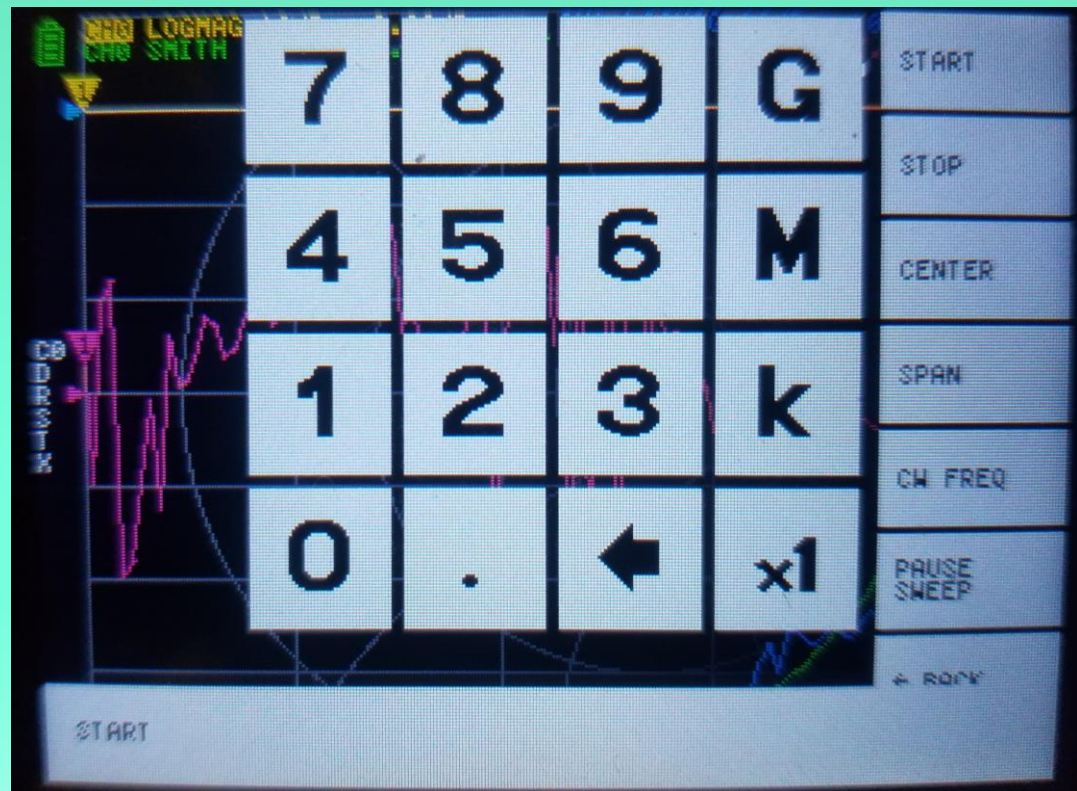

NanoVNA Block Diagram

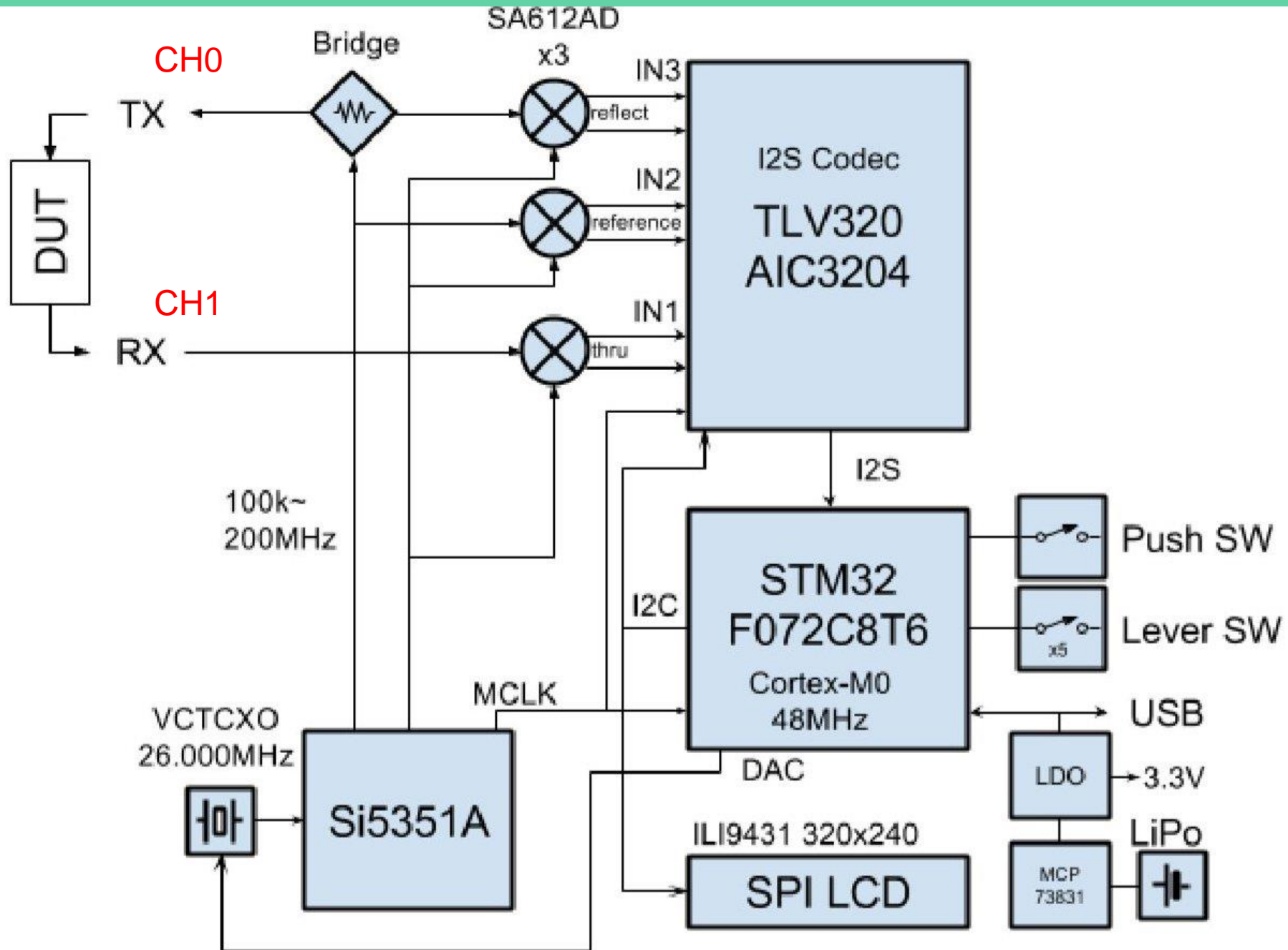

Calibration – a little tedious, but important

I have made my own
Female calibrators

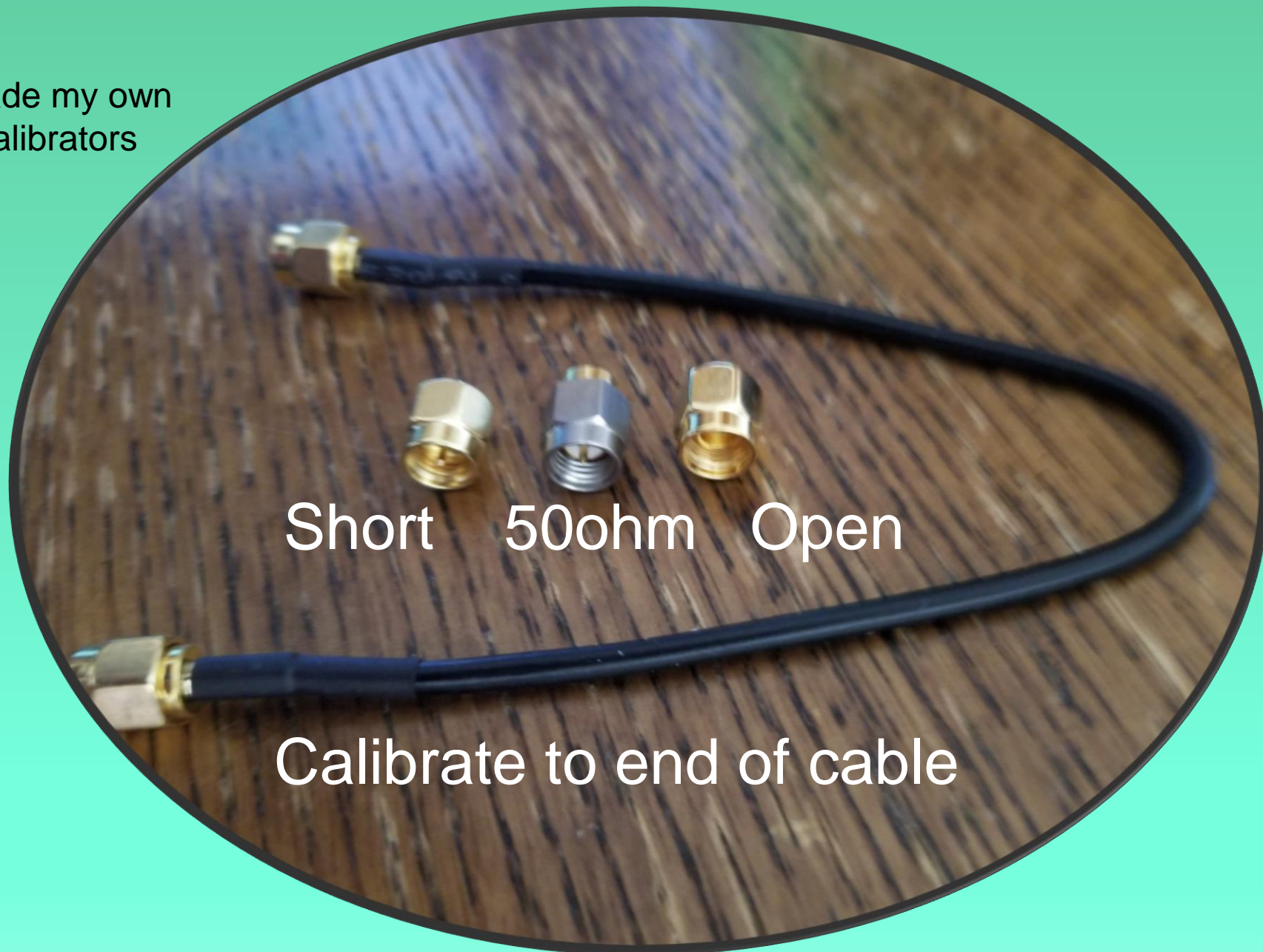

Short 50ohm Open

Calibrate to end of cable

Smith Chart – “Don’t Panic”

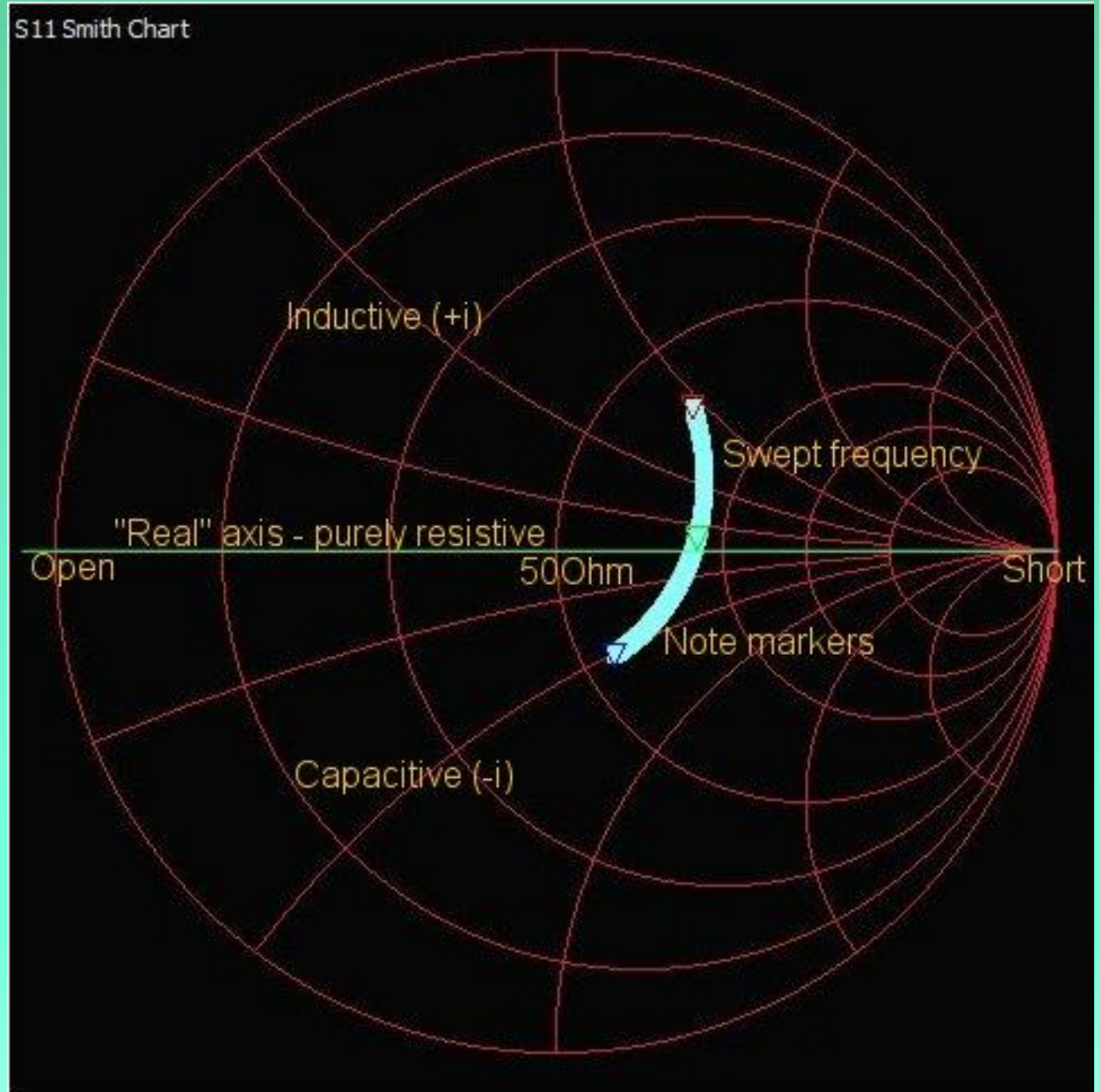

“Daytime” operating station



HF 30ft whip on 65ft tower
“storm” level – 25ft
100ft LMR-400



4/20/20

V/UHF
“Layover” pole mount
50ft LMR-400

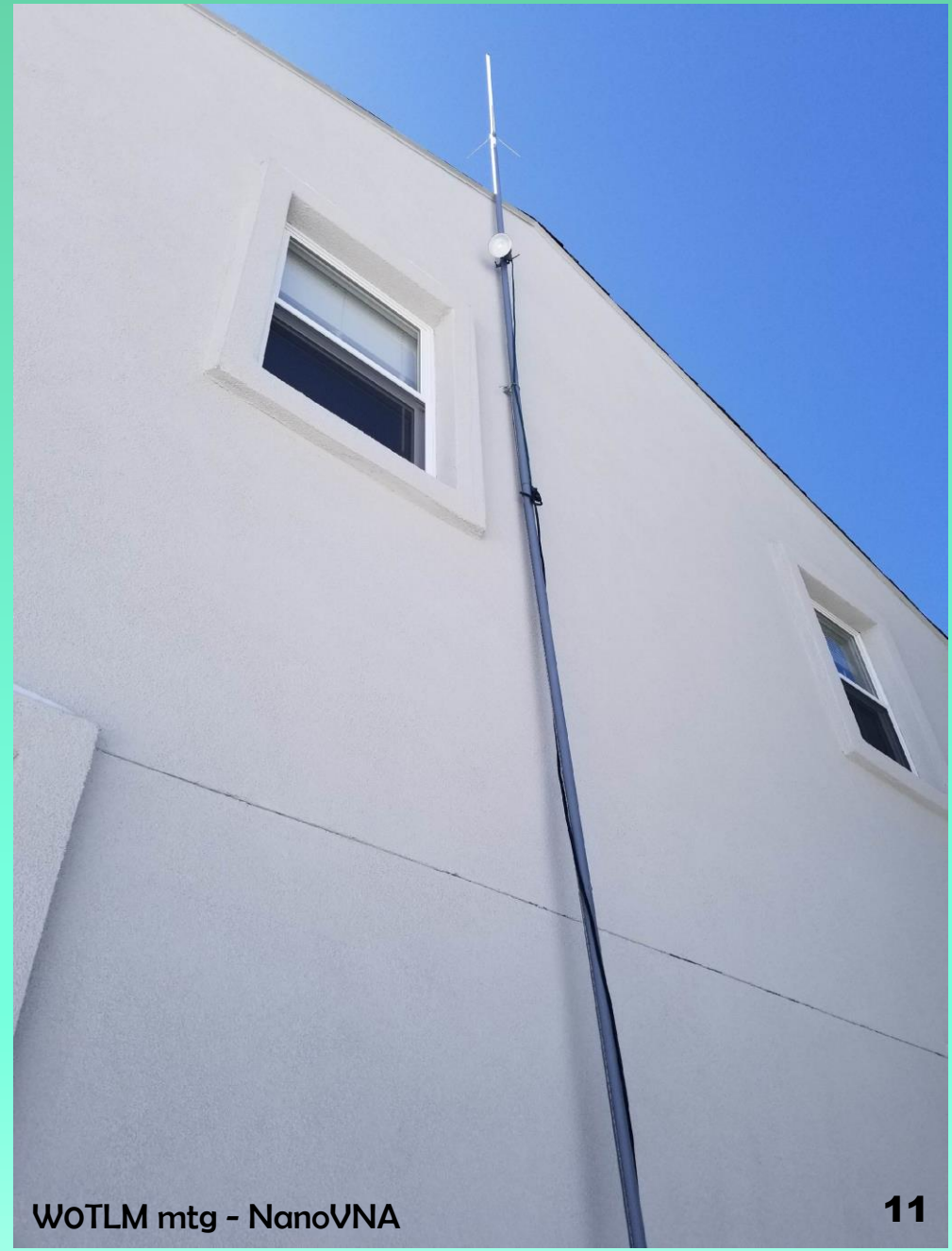

WOTLM mtg - NanoVNA

11

20m – 30ft whip on tower

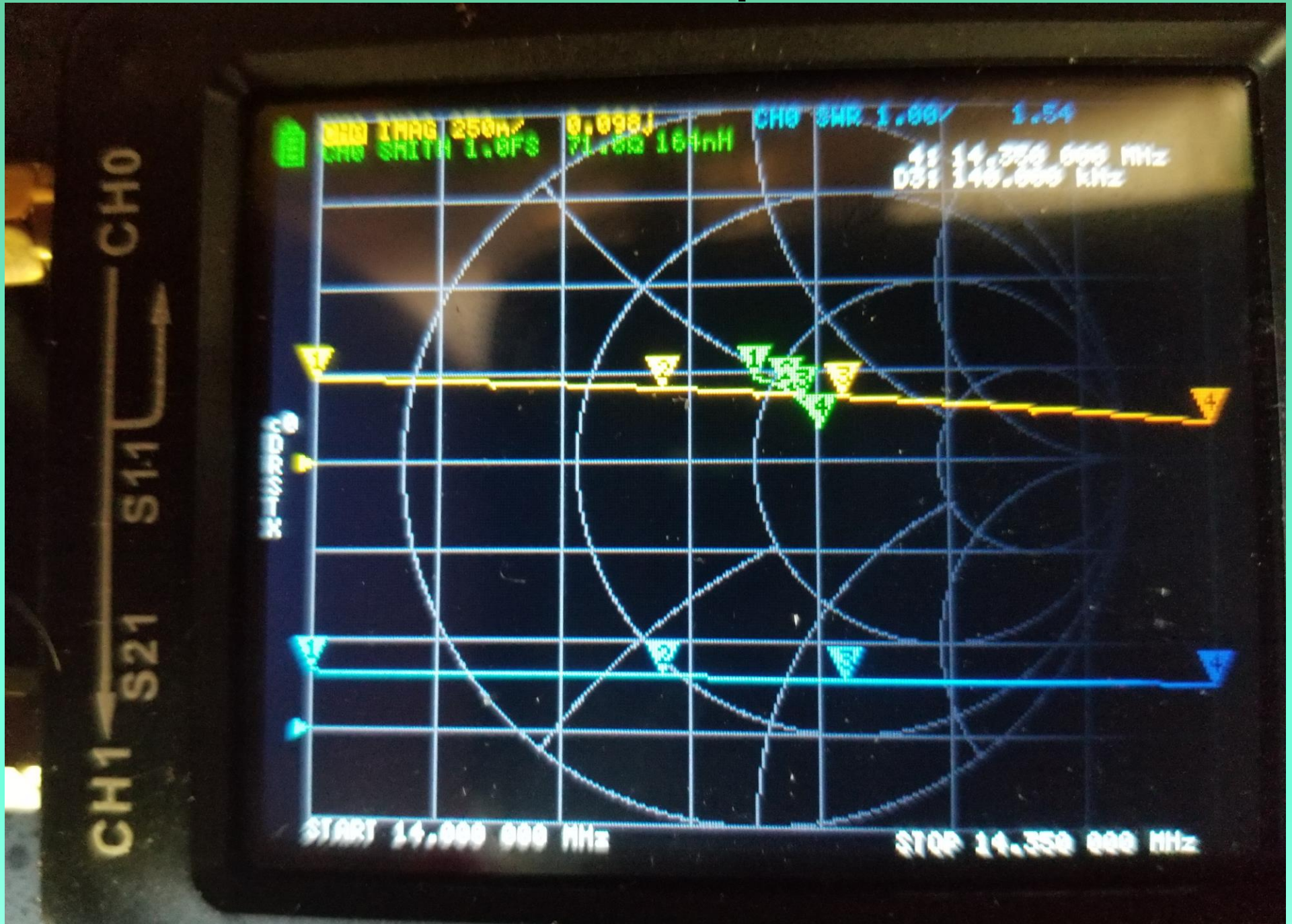

20m 30ft Whip

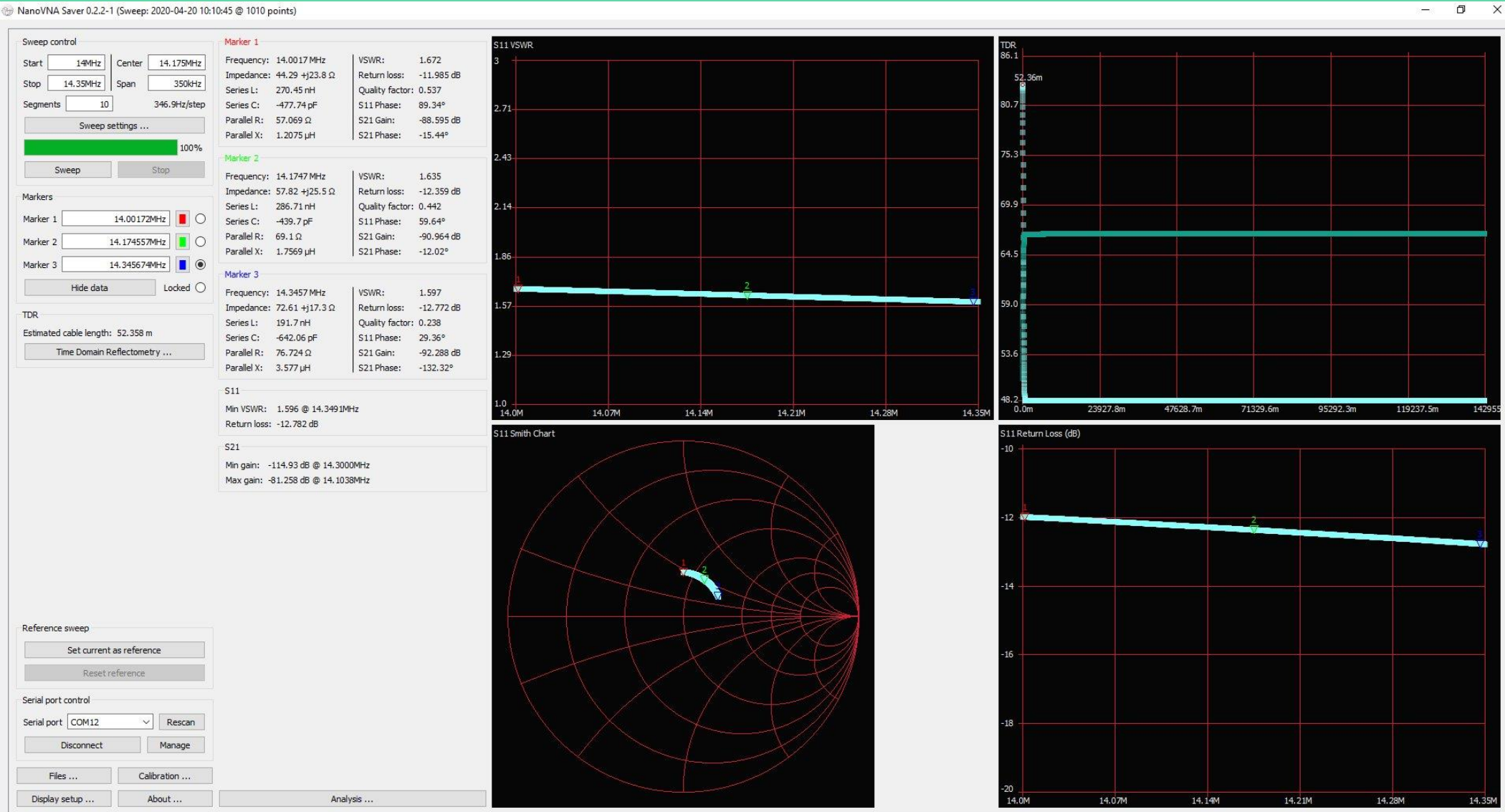

30ft Whip – 1 to 30 MHz

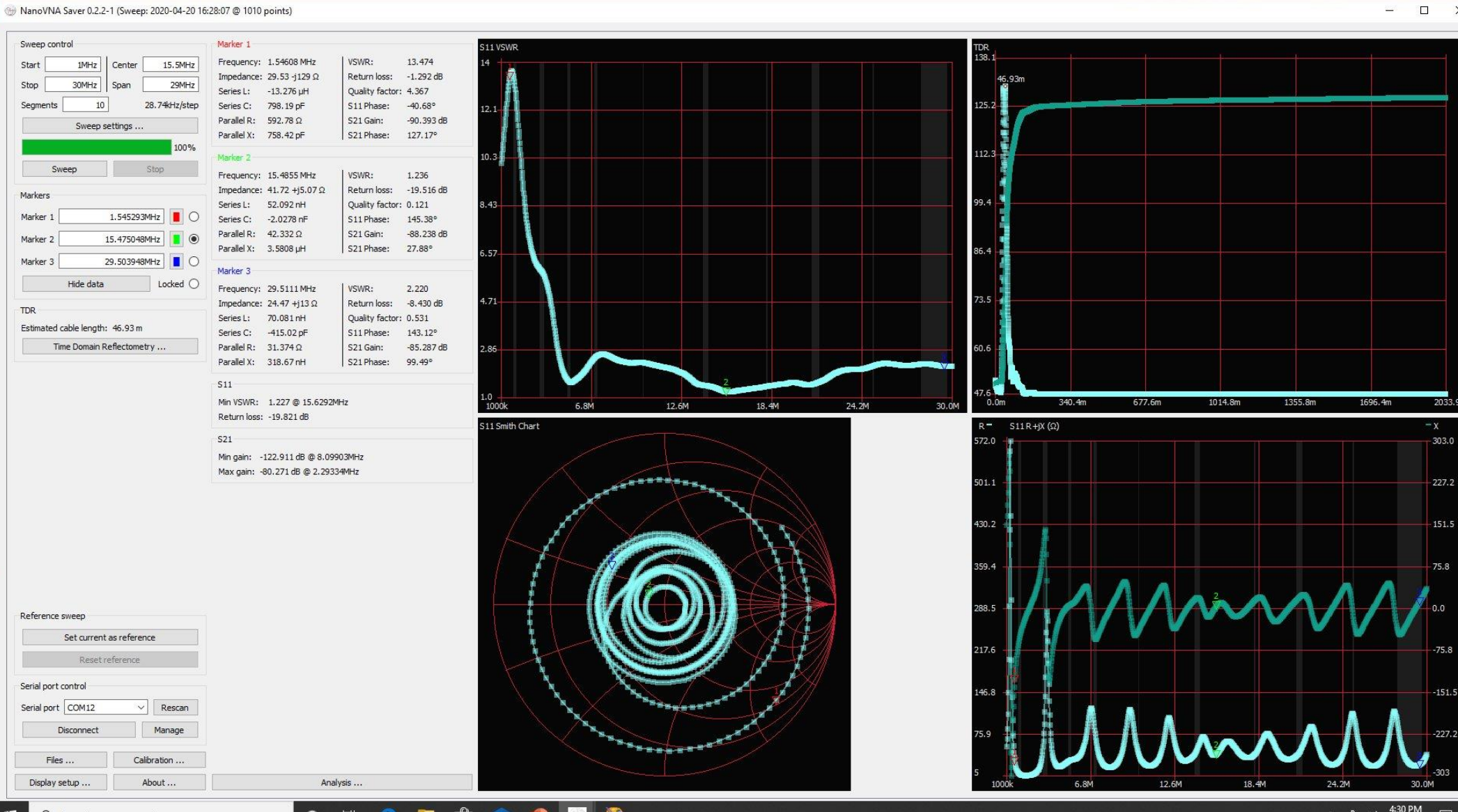

Dual band base station 100-500MHz

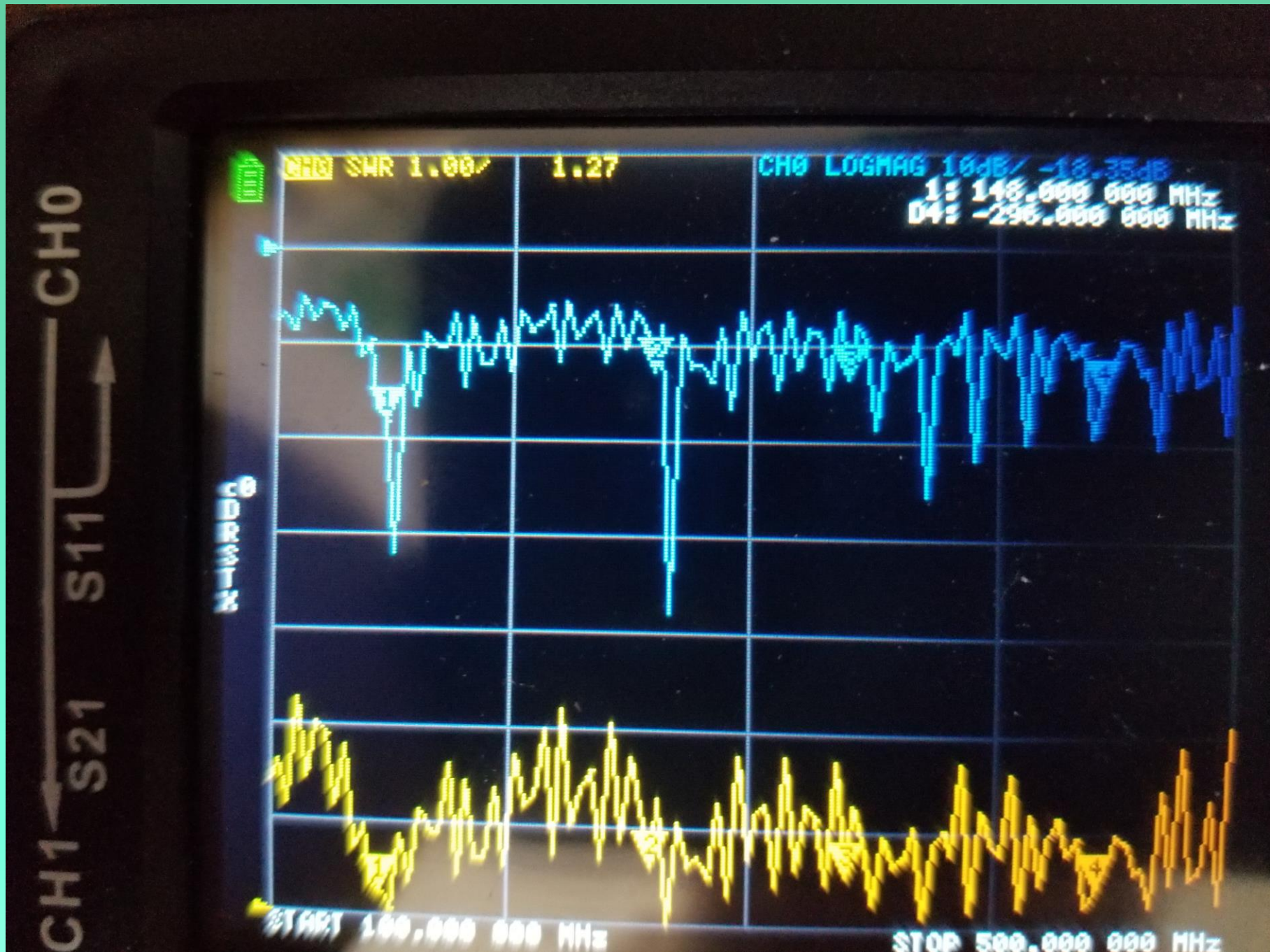

Dual band base station 2m

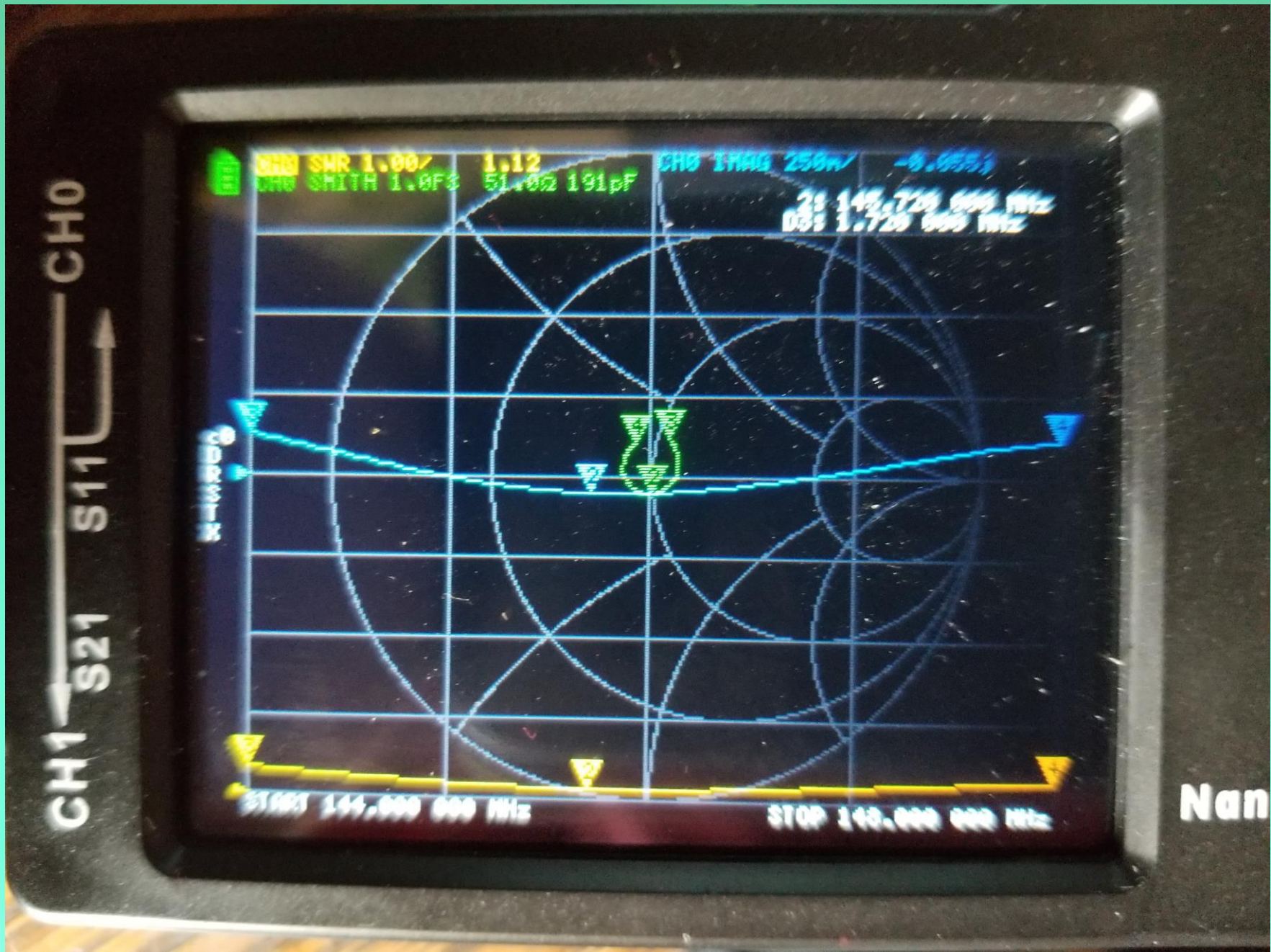

Dual band base station 2m

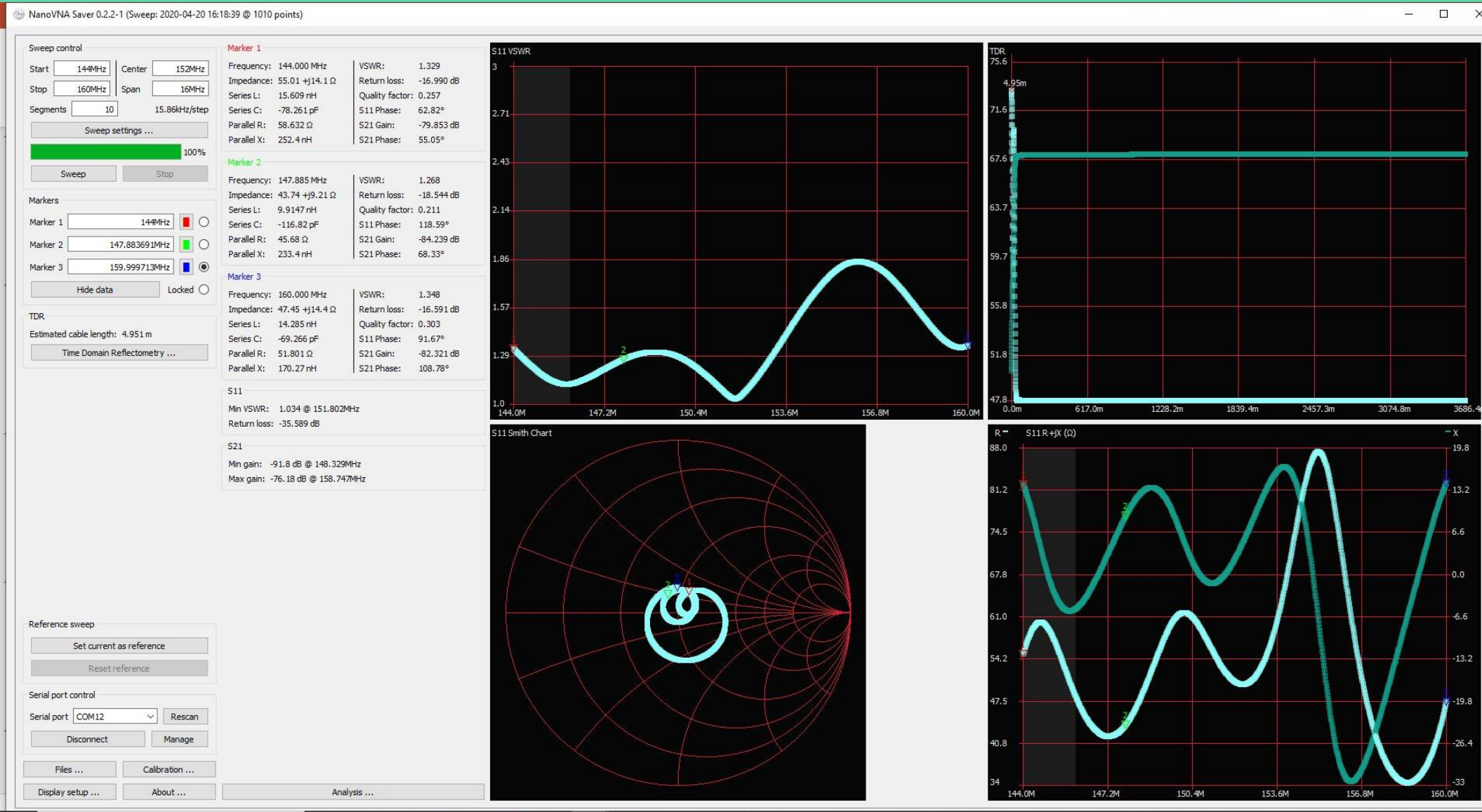

“Nighttime” Station – electronics bench



“Nighttime” Station 80m Off Center Fed dipole & Quadband



Quadband Antenna – 2m band

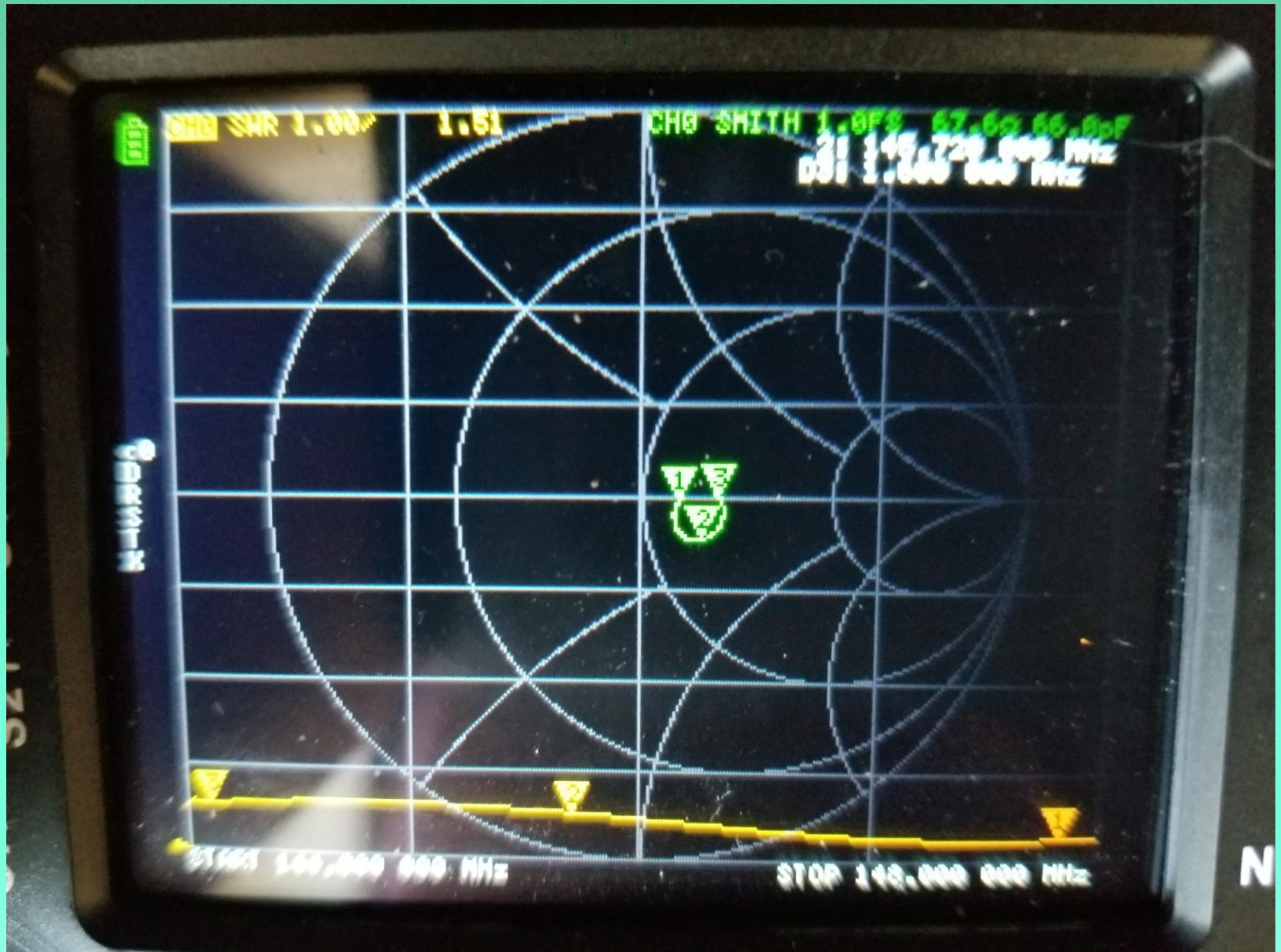

Quad band 2m band

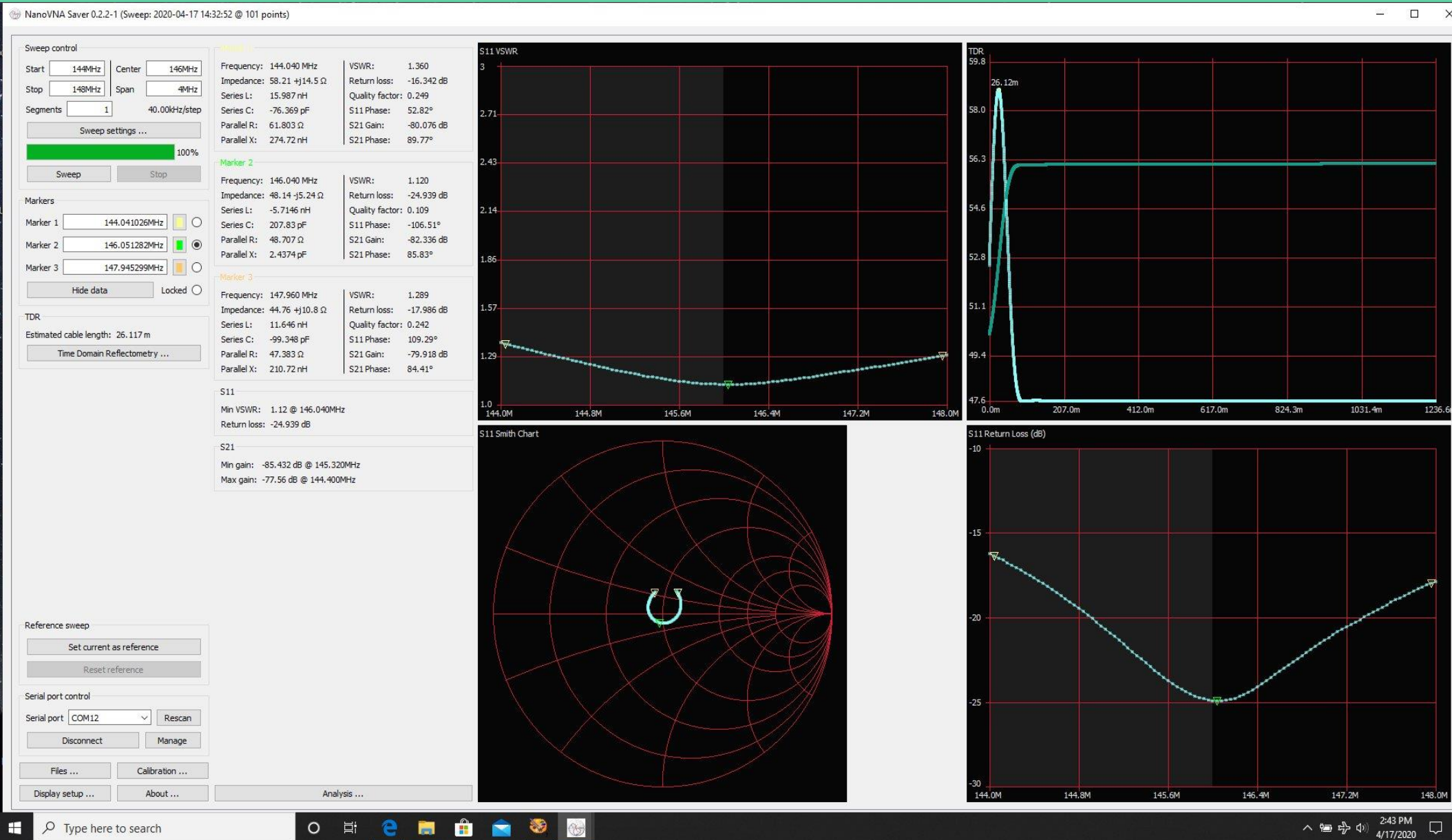

Off center fed dipole – 40m band

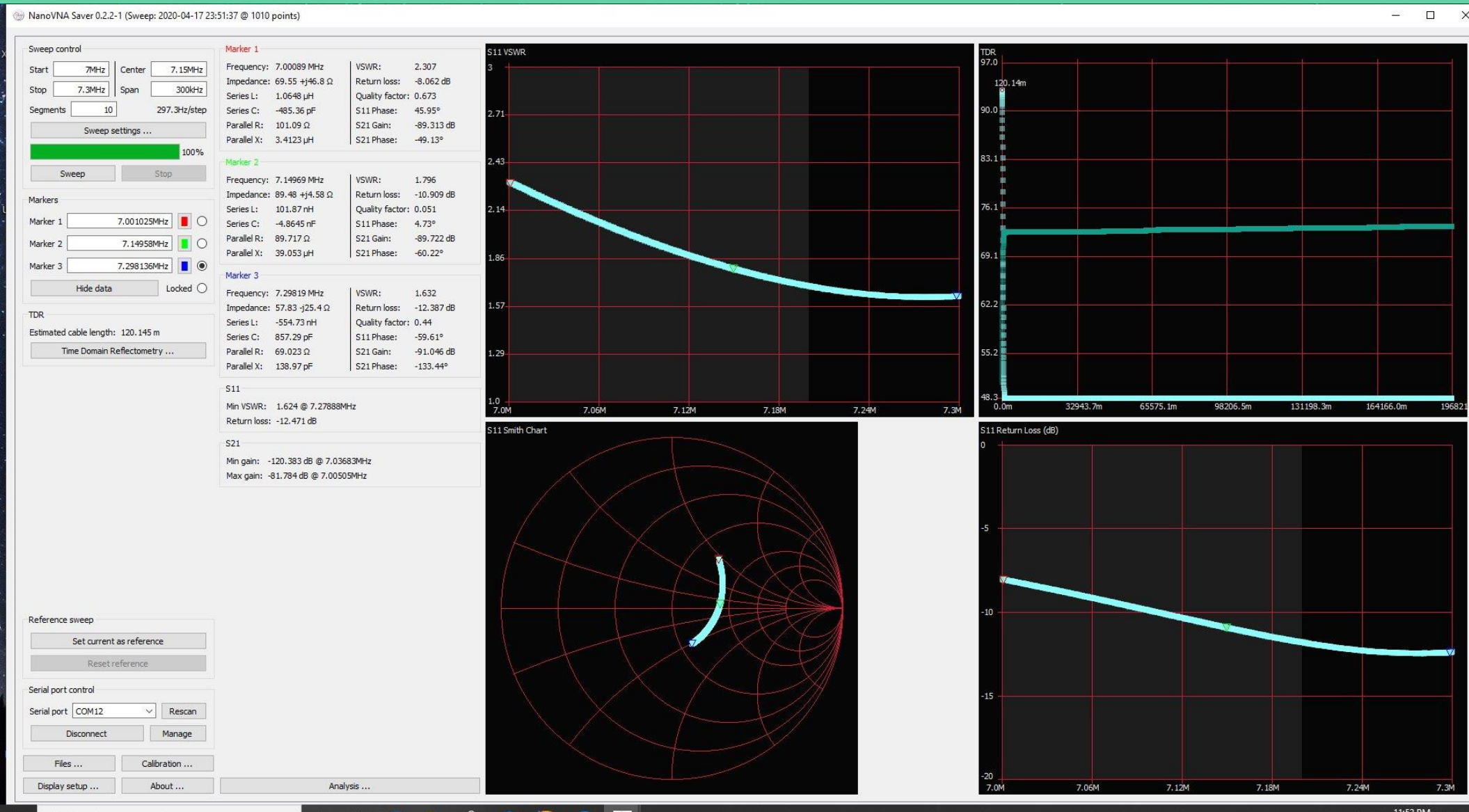

HF 80m Off Center Fed Dipole, 1 TO 30MHz

Note: One objection to nanoVNA is fixed 100 samples – with software segments can multiply this by any number – here 10 segments, 1000 pts

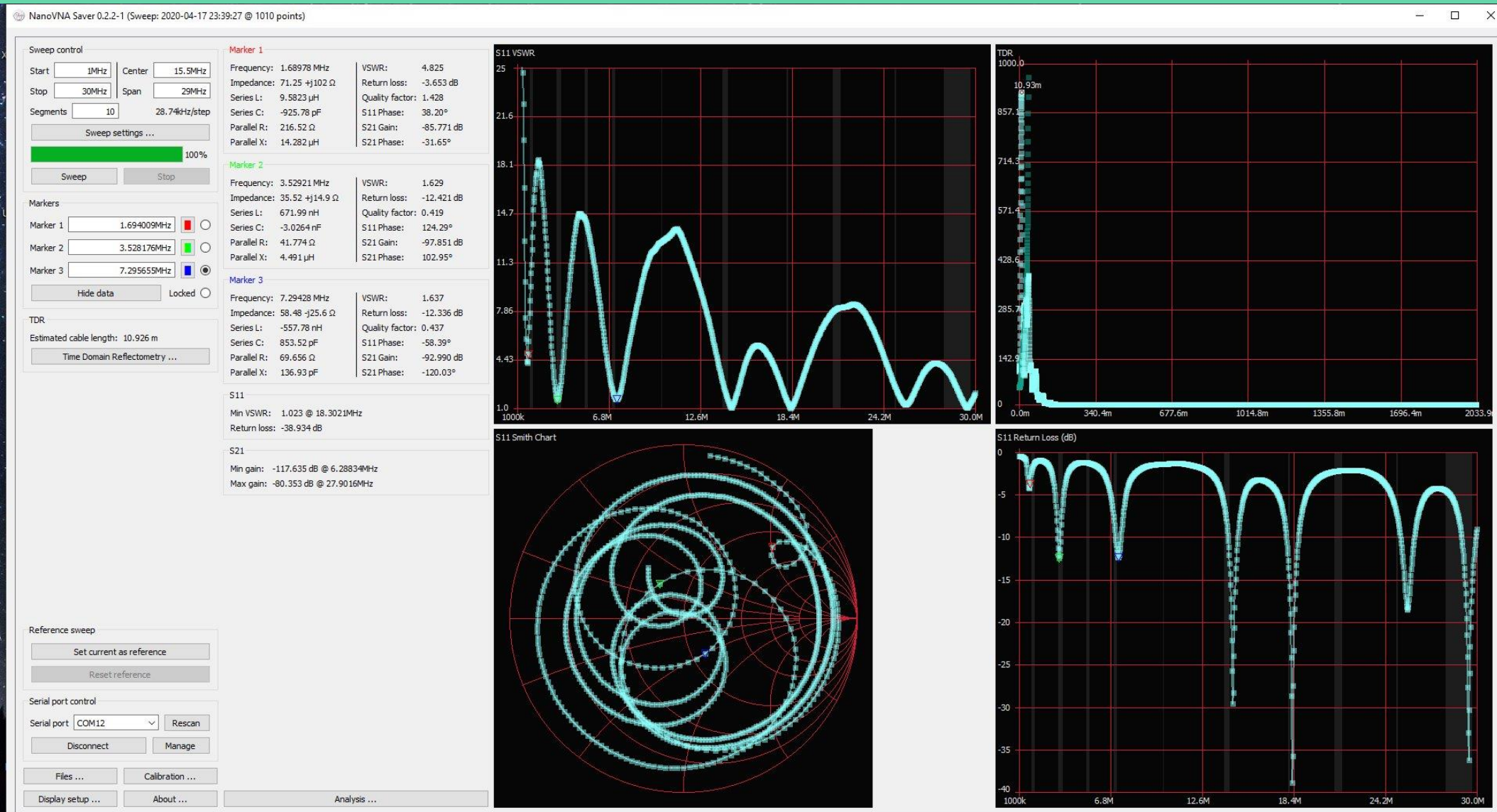

2 port – Cable testing



2 port – Cable testing

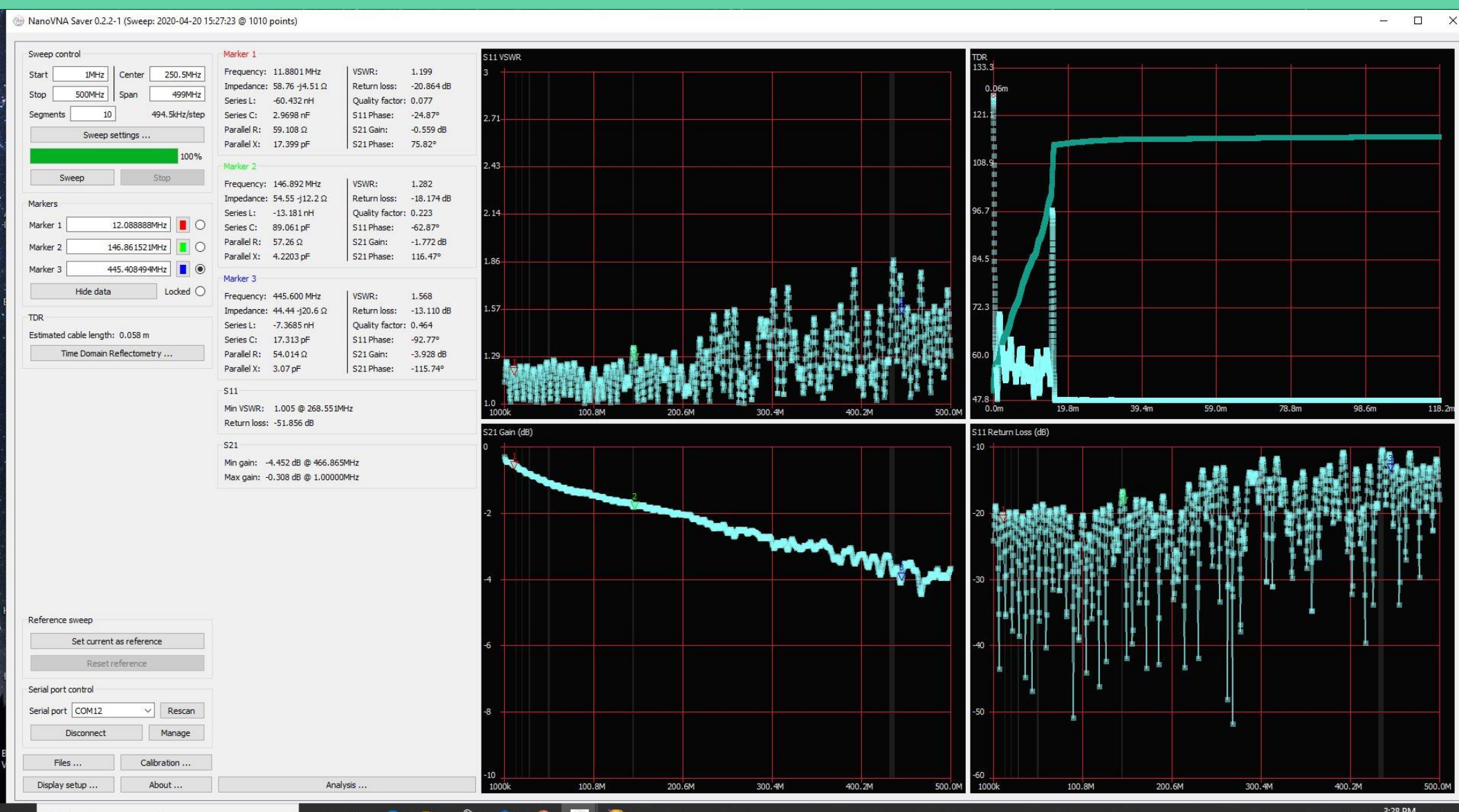

Cable Testing – 1 port (open far end), TDR

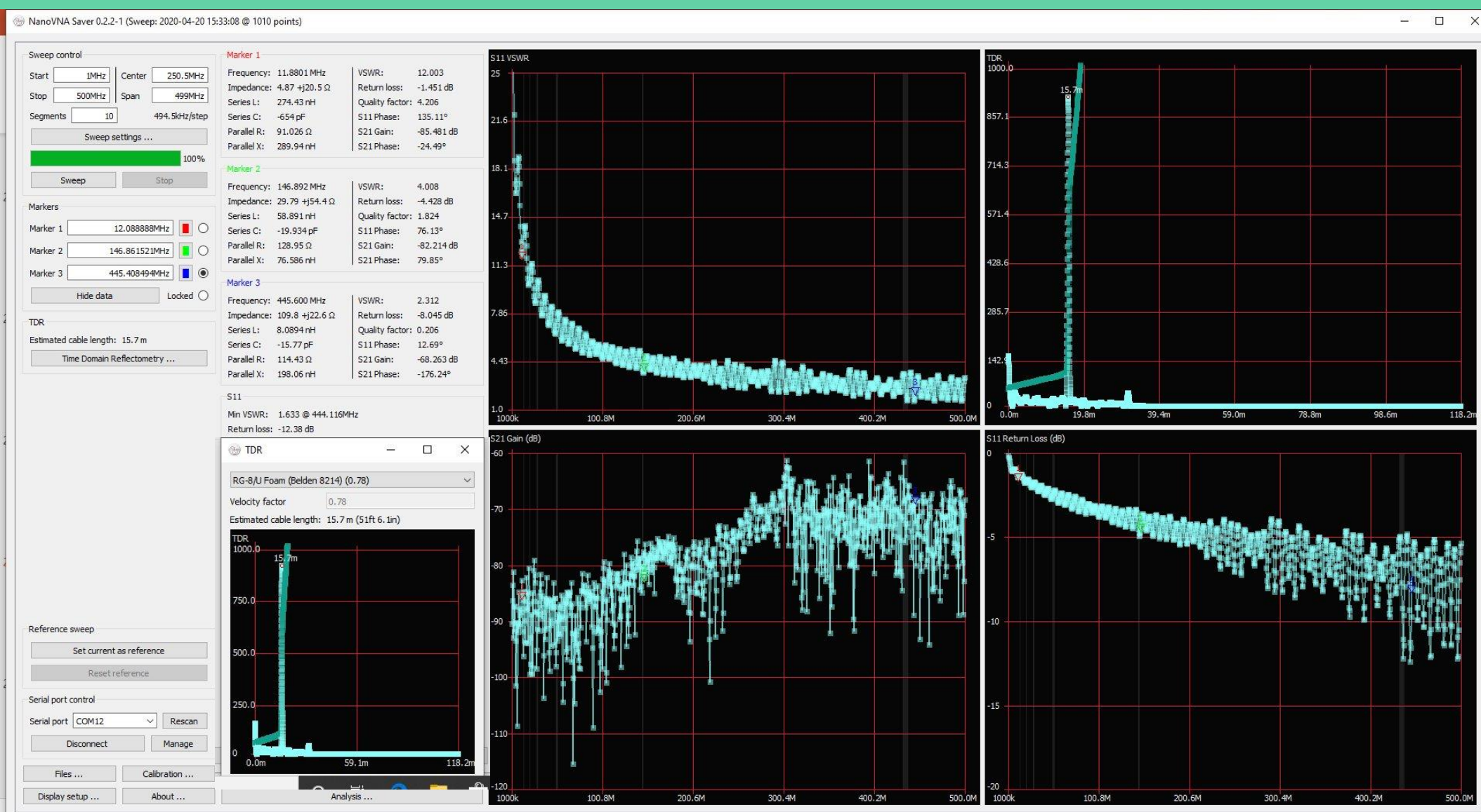

NanoVNA takeaways

- Amazing instrument! Especially with the “NanoVNA Saver” program.
- NanoVNA and a multimeter meets 95% of ham testing needs. I have at least a half dozen antenna analyzers and SWR meters – this replaces them all.
- Eminently justifiable if just used as SWR and cable tester, but so much more.
- When buying, check the reviews! – many different makers, some very good, some not so much. Pay a little more and get full case, calibrators, cables – much cheaper with unit than bought separately.
- Adapters – you will need a few to many – SMA male to SO239, PL259 (“UHF” male and female), SMA male to BNC, cables, etc, etc..
- User interface is quite useable, but takes some getting used to – get a stylus!